



**CENTRE FOR PHYSICAL EDUCATION**  
**MANONMANIAM SUNDARANAR UNIVERSITY,**  
**TIRUNELVELI**



**INTERCOLLEGIATE TOURNAMENTS 2017-18**  
**GUIDELINES**

1. All the teams/Athletes will be permitted to participate in inter-college tournaments only with proper playing kit and uniforms prescribed for the particular discipline.
2. All college teams shall participate in the Inter- College Tournaments in their registered respective colours. In case of clash of colours between the two teams it shall be decided by the spin of coin as to which teams will the playing uniform other than of its own colour to be supplied.
3. All the teams/participants should report to the organizing secretary of the championship half an hour before scheduled time for the commencement of the tournament.
4. All the teams shall have to be accompanied by a team manager preferably the Physical Education Faculty member or a teaching staff of the college deputed by the Principal. The name of the Manager with his/her designation should be entered in the eligibility proforma and only such person has the right to perform the duty of the Team Manager. If the team is accompanied by a Coach or any other person (other than the Manager), the Principal should authorize person with a letter of authority. No unauthorized persons shall act as the team manager or coach.
5. Only permitted number of students/actual participants needs to be entered in the eligibility proforma. The organizing secretary should verify and sign the same before forwarding it to the University.
6. If a team withdraws from the championship after giving the entry /drawing the fixture with valid reasons, they should inform the matter to the Director, Centre for Physical Education and the Organizing Secretary well in advance.
7. If a team withdraws from the championship after giving the entry /drawing the fixture without valid reasons shall be penalized along with fine amount of Rs 500/.
8. Students undergoing disciplinary action in the colleges will not be allowed to participate in the inter-college tournaments.
9. Every college sending its team to participate in an Inter-college Tournament shall appoint a whole time employee, responsible staff member as its attached representative and due intimation of such an appointment shall be sent to the organizing college.

10. For purpose of nominating coaches to accompany the College Team, the condition of employment in College shall not be insisted upon. However, while nominating non-employees as coaches the college should ensure that they, in no way, violate the rules and regulations governing Inter-college Championships. In case of any violations the concerned college will have to take responsibility for their actions. As regards Managers, they should be "Employees" of the college.
11. Under no circumstances shall a team be allowed to participate in a tournament unless accompanied by an accredited representative as defined above.
12. Any college team member/coach/manager involving an act of misbehavior will result in the debarring of the team for that academic year. The matter should be brought to the notice of the University and the concerned principals of the college. The debarred college will not be given any inter-college tournaments to organize in the next three years.
13. In case of personal / property damage caused by the participating individual/college the cost will be recovered from the individual/ college concerned.
14. Participating colleges shall bear T.A. & D.A., incidental and the boarding expenses of its own teams/individual athletes for INTER-COLLEGE tournaments.
15. ***The following documents are required/submitted to the organizing secretary to participate in the Inter-college tournaments;***
  - a. The manager should submit the eligibility proforma in the prescribed format available in the web page (<http://msuniv.ac.in/sports.aspx>) duly filled and signed by the Principal. All columns of the eligibility certificate have to be filled. No over writing or correction is permitted in the eligibility proforma.
  - b. The participants should also produce the college identity cards duly signed by the Principal at the time of the competition. The signatures of the attesting authority must be on the photograph. The player(s) not carrying identity cards shall not be allowed to participate in the concerned tournament.
  - c. Attested Photo copy of the pass certificate of +2 examination
  - d. Attested Photo copy of the pass certificate of degree course (PG students only).
  - e. 1<sup>st</sup> year students (UG & PG) must submit Admission fees receipt and others are asked to submit registration number in the eligibility proforma.
  - f. The students who are 'REDO' the course shall not be eligible to participate.
  - g. Only a ***bonafide***, full time student, who is enrolled for a course of the college, which is of a minimum duration of one academic year, and whose examination is conducted by the university, shall be eligible to participate in the Inter-College tournaments.



**CENTRE FOR PHYSICAL EDUCATION**  
**MANONMANIAM SUNDARANAR UNIVERSITY**  
**TIRUNELVELI – 627 012**



**MSU INTER-COLLEGE TOURNAMENTS 2017-18**  
**SPORTS CALENDER - MEN**

Sl.No	Game	Tournament Date	University Selection Trials Date	Venue
1	Chess	Aug 23-24, 2017 (Reporting time 11am)	Aug 24, 2017 (7am)	MSU Con. College, Kadayanallur
2	Cricket	Aug 26-Sep 1, 2017	Sep 1, 2017 (10am)	1. ST Hindu (Z&IZ), 2.GVN, 3.VOC 4. Aditanar
3	Swimming (M & W)	Sep 5, 2017 (8am)	Sep 5, 2017 (8am)	APA College, Naguneri (Venue:Anna Stadium, Tirunelveli)
4	Tennis	Sep 11-12, 2017 (2pm)	Sep 12, 2017 (7am)	VOC College, Thoothukudi.
5	Table Tennis	Sep 11, 2017 (8am)	Sep 11, 2017 (8am)	VOC College, Thoothukudi.
6	Handball	Sep 14-16, 2017	Sep 16, 2017 (7am)	Sadakathullah Appa College, Palayamkottai
7	Badminton	Sep 18-19, 2017 (8am)	Sep 19, 2017 (8am)	Lekshmpuram College, Neyyor
8	Cross Country Race	Sep 21, 2017 (7am)		MS University, Tirunelveli
9	Basketball	Sep 20-22, 2017	Sep 22, 2017 (2pm)	The MDT Hindu College, Tirunelveli
10	Weightlifting (M & W)	Sep 23, 2017 (8am)	Sep 23, 2017	TDMNS College, T.Kallikulam
11	Ball Badminton	Sep 25-27, 2017	Sep 27, 2017 (2pm)	Sri Ram Nallamani Yadav College, Tenkasi
12	Football	Oct 04-07, 2017	Oct 7, 2017 (2pm)	St. Xavier's, Palay & Aditanar College, Tiruchendur
13	Volleyball	Oct 11-14, 2017	Oct 14, 2017 (7am)	St. Xavier's College, Palayamkottai
14	Hockey	Oct 20-21, 2017	Oct 21, 2017 (2pm)	K.R. College of Arts & Science, Kovilpatti
15	Kho-Kho	Oct 23-24, 2017	Oct 25, 2018 (7am)	Nanjil College, Kaliyakkavilai
16	Kabaddi	Dec 13-15, 2017	Dec 15, 2017 (2pm)	MS University, Tirunelveli
17	Athletics (M & W)	Dec 19-21, 2017		MS University, Tirunelveli (Anna Stadium)
18	Teakwondo, Boxing and Fencing etc.,	Request to be submitted on or before August 31, 2017 for the eligible students with necessary documents through proper channel.		

**Note:** The schedule may be advanced / postponed according to the dates of South Zone/All India interuniversity tournaments received then and there.



**CENTRE FOR PHYSICAL EDUCATION**  
**MANONMANIAM SUNDARANAR UNIVERSITY**  
**TIRUNELVELI – 627 012**



**MSU INTER-COLLEGE TOURNAMENTS 2017-18**  
**SPORTS CALENDER - WOMEN**

Sl.No	Game	Tournament Date	University Selection Trials Date	Venue
1	Chess	Aug 23-24, 2017 (Reporting time 11am)	Aug 24, 2017 (10am)	MSU Con. College, Kadayanallur
2	Table Tennis	Aug 24, 2017	Aug 24, 2017 (2pm)	Sri Parasakthi College, Courtallam
3	Swimming	Sep 5, 2017	Sep 5, 2017	APA College, Naguneri (Venue: Anna Stadium, Tirunelveli)
4	Ball Badminton	Sep 11-12, 2017	Sep 12, 2017 (2pm)	St. Mary's College, Thoothukudi
5	Kho-Kho	Sep 11-13, 2017	Sep 13, 2017 (7am)	St. Mary's College, Thoothukudi
6	Badminton	Sep 19-20, 2017	Sep 20, 2017 (8am)	Lekshmpuram College, Neyyor
7	Cross Country Race	Sep 21, 2017 (7am)		MS University, Tirunelveli
8	Weightlifting	Sep 23, 2017 (8am)	Sep 23, 2017	TDMNS College, T.Kallikulam
9	Football	Sep 25-27, 2017	Sep 27, 2017 (7am)	MSU College, Puliangudi
10	Kabaddi	Sep 26-28, 2017	Sep 28, 2017 (2pm)	MSU College, Puliangudi
11	Volleyball	Oct 9-11, 2017	Oct 11, 2017 (7am)	WCC, Nagercoil
12	Hockey	Oct 25-27, 2017	Oct 27, 2017 (7am)	MSU College, Kadayanallur
13	Basketball	Dec 11-12, 2017	Dec 12, 2017 (2pm)	Rani Anna Govt. College for Women, Tirunelveli.
14	Athletics	Dec 19-21, 2017	Dec 19-21, 2017	MS University, Tirunelveli (Anna Stadium)
15	Handball	January, 2018	----	MS University, Tirunelveli
16	Teakwondo, Boxing and Fencing		Request to be submitted on or before August 31, 2017 for the eligible students with necessary documents through proper channel.	

**Note:** The schedule may be advanced / postponed according to the dates of South Zone/All India interuniversity tournaments received then and there.



## CRICKET (MEN) – POOL C

**Venue:** Aditanar College, Tiruchendur. **Date:** Aug 26- 31, 2017

Team	R1	R2	R3	R4	Q.F
1. ADITANAR (SF)					
2. NOORUL ISLAM					
3. MSU NAGALAPURAM					
4. MUSLIM ARTS					
5. MSU GOVINDAPERI					
6. ARIGNAR ANNA					
7. NMCC					
8. CSI NALLUR					
9. KAMARAJ TUTI.					
10. PMT					
11. MSU PULIANGUDI					
12. St.JEROME'S					

## CRICKET (MEN) – POOL D (ZONE & INTER ZONE)

**Venue:** S.T. Hindu College, Nagercoil. **Date:** Aug 26- 31, 2017

Team	R1	R2	R3	R4	Q.F
1. ST HINDU					
2. RAJALAKSHMI					
3. KR ARTS					
4. MSU SANKARANKOVIL					
5. MSU KADAYANALLUR					
6. ALPHONSA					
7. TDMNS					
8. St.JUDE'S					
9. SIVANTHI ADITANAR					
10. EINSTEIN					
11. MSU DEPT					
12. SCOTT (W)					

- ❖ Semifinal 1: Pool A vs Pool B – 31.08.17, 8.00am at S.T Hindu College, Nagercoil.
- ❖ Semifinal 2: Pool C vs Pool D – 31.08.17, 1.00pm at S.T Hindu College, Nagercoil.
- ❖ Losers Final - 01.09.17, 6.30am at S.T Hindu College, Nagercoil.
- ❖ Final - 01.09.17, 11.30 am at S.T Hindu College, Nagercoil.
- ❖ Matches will be played on 20 over basis.
- ❖ SS Yorker cricket ball only used for the matches.

## TENNIS (MEN)

**Venue:** VOC College, Thoothukudi. **Date:** Sep 11-12, 2017

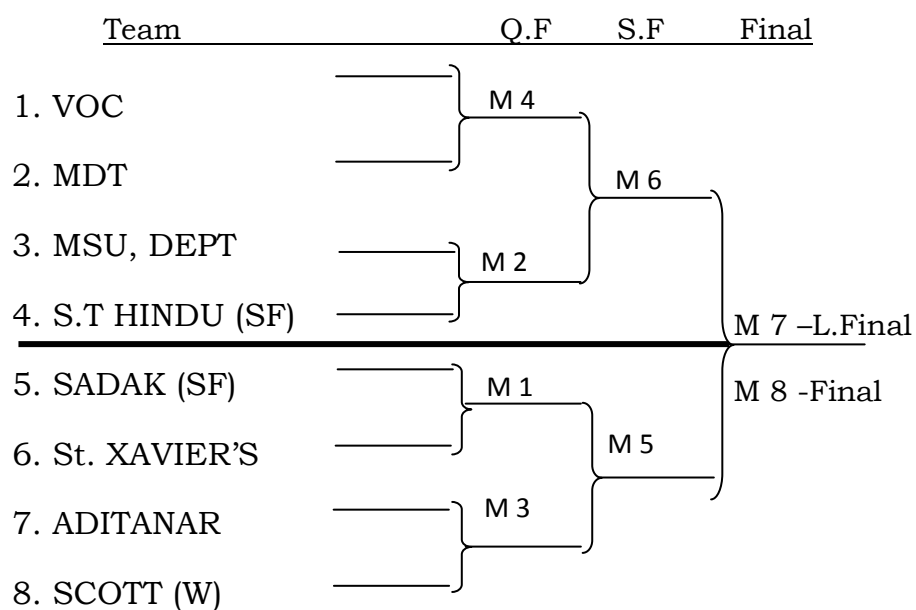

\*Reporting Time – Sep 11, 2017 at 2.00 pm.

Organizing Secretary: **Dr.P.SIVAGNANAM**, DPE (9843149748)

## TABLE TENNIS (MEN)

**Venue:** VOC College, Thoothukudi

**Date:** Sep 11, 2017

Team	R1	Q.F	S.F	Final
1. S.T HINDU (R)	_____			
2. GVN				
3. ADITANAR				
				M 9
4. St. JEROMES				
5. St. JOHN'S PALAY				
6. VOC (SF)				
				M 10-L.Final
7. NANJIL (SF)				
8. MDT				
9. SADAK				
				M 8
10. St. XAVIER'S				
11. SCOTT (W)				

\*Reporting Time - Sep 11, 2017 at 8.00 am.

Organizing Secretary: **Dr.P.SIVAGNANAM**, DPE (9843149748)



## HANDBALL (MEN)

**Venue:** SadakathullahAppa College, Tirunelveli

**Date:** Sep 14-16, 2017

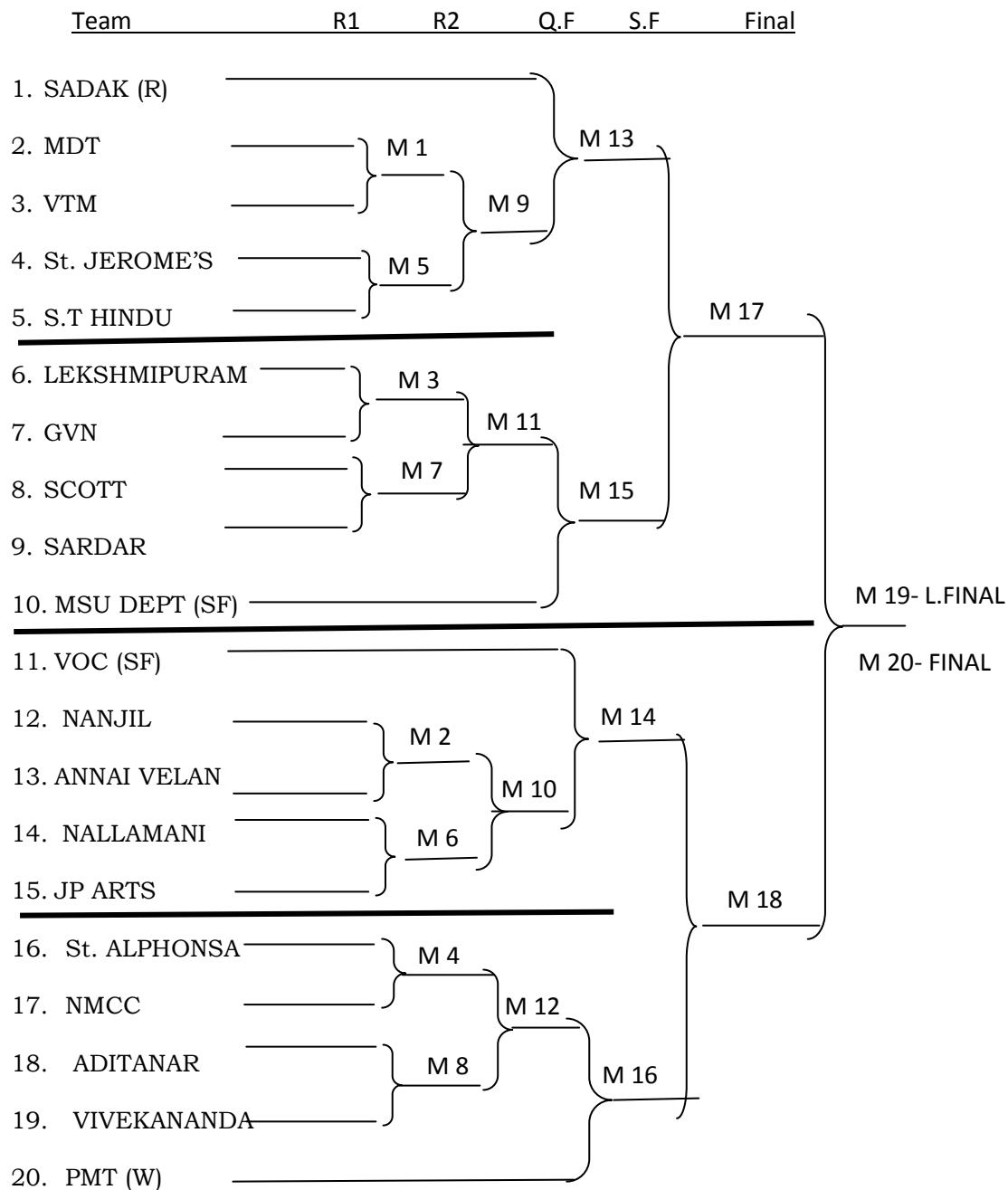

\*Reporting Time – Sep14, 2017at 7.00 am.

Organizing Secretary: **Mr. M. SYED ALI, DPE,(9942322874)**

## BADMINTON(MEN)

**Venue:** Lekshmipuram College, Neyyor, K.K.Dist

**Date:** Sep 18-19, 2017

Team	R1	R2	R3	Q.F	S.F	Final
1. VOC(R)						
2. MDT						
3. MK. CATHOLIC						
4. MSU DEPT						
5. SSDM						
6. TIRUVALLUVAR						
7. RUBEN						
8. KAMARAJ TUTI						
9. S.T HINDU						
10. POPE'S						
11. CSI						
12. RAJALAKSHMI						
13. NANJIL						
14. LEKSHMIPURAM						
15. ST. JUDES						
16. ST. ALPHONSA						
17. NMCC (SF)						
18. St. JOHN'S PALAY (SF)						
19. VTM						
20. SADAK						
21. MUSLIM						
22. VIVEKANANDA						
23. DON BOSCO						
24. NOORU ISLAM						
25. PERARIGNAR						
26. GVN						
27. TMN COLLEGE						
28. ST. XAVIERS						
29. ADITANAR						
30. SPKC						
31. SRI SANKARA						
32. ST. JEROME'S						
33. ANNAI						
34. SCOTT (W)						

\*Reporting Time – Sep18, 2017 at 8.00 am.

Organizing Secretary: **Mr. A. JERIN JOSE, DPE, ( 9443450789)**

## BASKETBALL (MEN)

**Venue:** The MDT Hindu College, Tirunelveli

**Date:** Sep 20-22, 2017

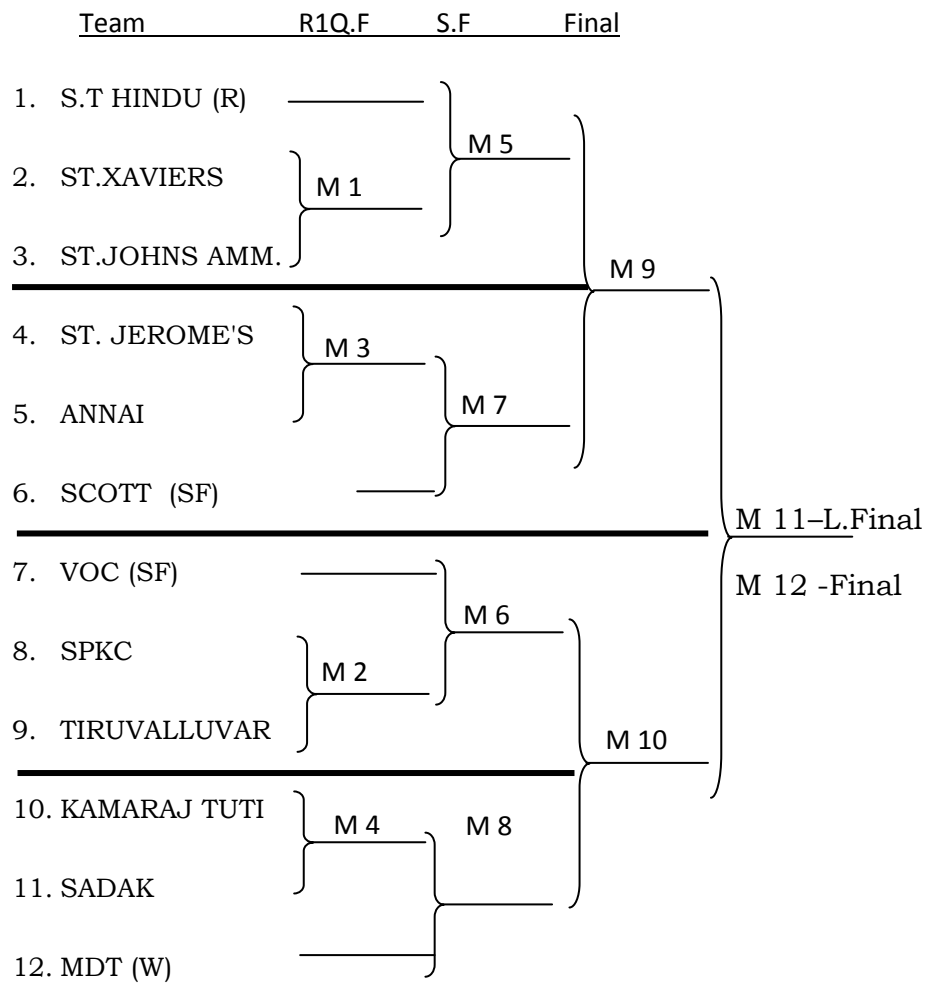

\*Reporting Time - Sep 20, 2017 at 2.00pm.

Organizing Secretary: **Dr.M.KANDASAMY, DPE, (9486614010)**

## BALL BADMINTON (MEN)

**Venue:** Sri Ram Nallamani Yadav College, Tenkasi **Date:** Sep 25-27, 2017

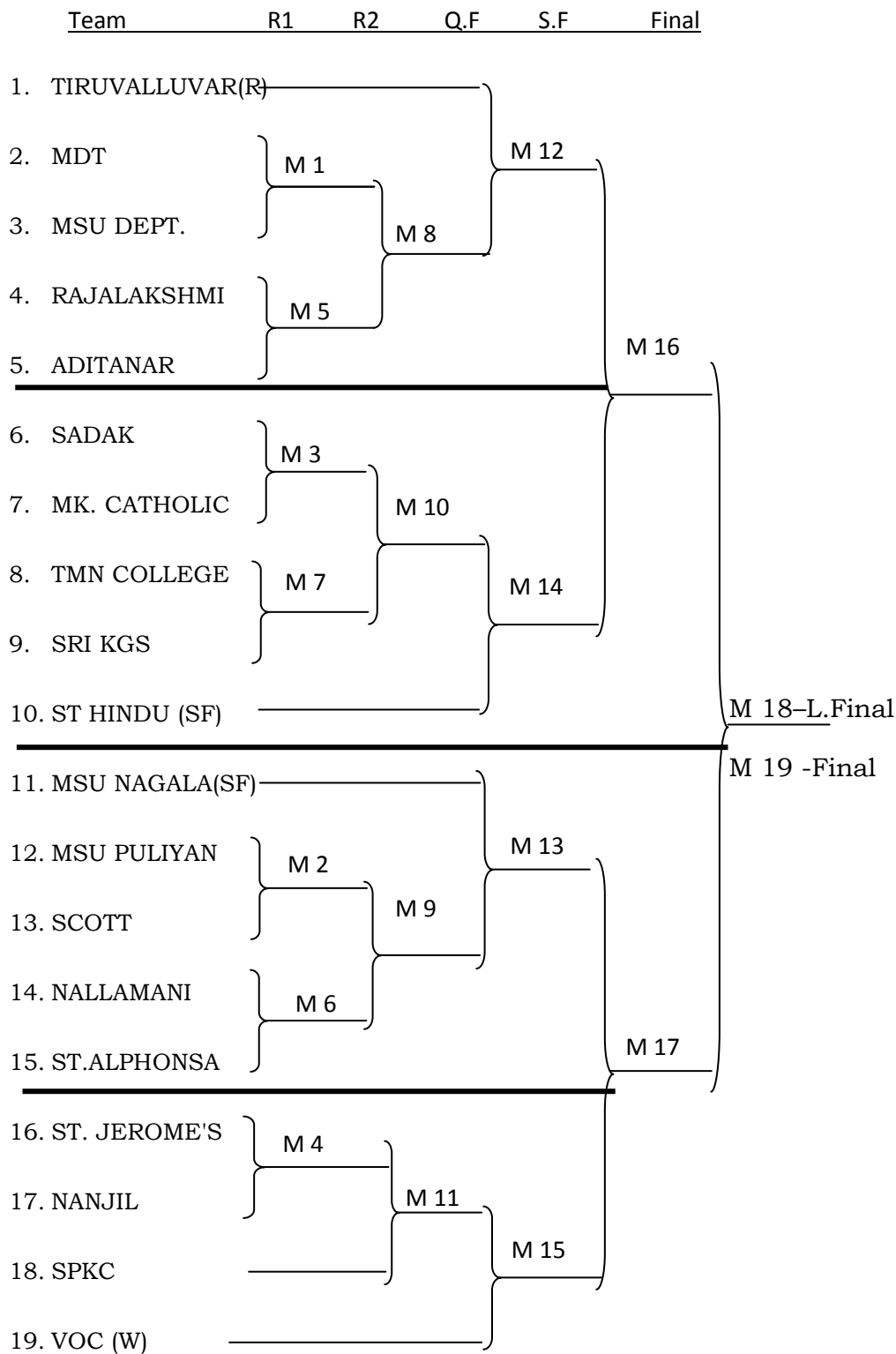

\*Reporting Time – Sep 25, 2017 at 2.00 pm.

Organizing Secretary: **Mr.S.SABARI KANTHAN, DPE (8883639763)**

## FOOTBALL (MEN)

**Venue:** Aditanar College of Arts & Science, Tiruchendur      **Date:** Oct 4-7, 2017

Team	R1	R2	R3	Q.F	S.F	Final
1. ADITANAR (R)						
2. MSU PULIYAN						
3. SPKC	M 1					
4. PMT						
5. MARGOSCHIS	M 3					
6. TIRUVALLUVAR		M 8				
7. VTM	M 5					
8. <b>KAMARAJ TUTI</b>						
9. MUSLIM		M 7				
10. ANNAI	M 2					
11. MK. CATHOLIC				M 11		
12. St. ALPHONSA	M 4					
13. SADAK		M 9				
14. St. JOHN'S AMM						
15. ST. JEROME'S						

\*Reporting Time – Oct 4, 2017 at 7.00am

Organizing Secretary: **Dr.D. Jim Reeves** Silent Night, DPE (9486317265)

**Venue:** St. Xavier's, College, Palayamkottai      Oct 4-7, 2017

Team	R1	R2	R3	Q.F	S.F	Final
16. SCOTT						
17. VOC						
18. NMCC	M 1					
19. KAMARAJ SURA		M 6				
20. GVN	M 3					
21. DON BOSCO		M 8				
22. NANJIL	M 5					
23. <b>CSI</b>						
24. JP ARTS		M 7				
25. MDT	M 2					
26. MSU DEPT				M 11		
27. St. JOHN'S PALAY	M 4					
28. St. XAVIER'S		M 9				
29. GOVT ARTS NAGER						
30. ST. JUDE'S (W)						

\*Reporting Time – Oct 4, 2017 at 7.00am

Organizing Secretary: **Dr. A. LAURENCE SELVARAJ, DPE (9443080418)**

(Final and looser final will be held at St. Xavier's College on 7.10.2017 at 7 am.)

## VOLLEYBALL (MEN)

**Venue:** St. Xavier's College, Palayamkottai.

**Date:** Oct 11-14, 2017

Team	R1	R2	R3	R4	Q.F	S.F	Final
1. VIVEKANANDA (R )							
2. LEKSHMIPURAM			M 16				
3. NOORU ISLAM				M 32			
4. SADAK	M 1		M 24				
5. SARDAR							
6. MUSLIM	M 9						
7. NALLAMANI					M 40		
8. SRI SANKARA	M 5		M 20				
9. CSI							
10. TDMNS	M 13			M 36			
11. MSU GOVINDAPERI							
12. SRI KGS			M 28				
13. MSU DEPT.							M 48
14. MSU PULIYANKUDI			M 18				
15. MSU NAGAMPATTI				M 34			
16. MDT	M 3						
17. MK. CATHOLIC			M 26				
18. ST.XAVIERS	M 11				M 42		
19. NMCC							
20. POPE'S	M 6						
21. SPKC			M 22				
22. SIVANTHI ADITANAR	M 14			M 38			
23. DON BOSCO							M 46
24. ANNAI			M 30				
25. ST.ALPHONSA							
26. ADITANAR (SF)							M 50- L.FINAL
27. KAMARAJ TUTI(SF)							
28. ST. JEROME'S			M 17				
29. ARIGNAR ANNA				M 33			
30. ENISTEIN	M 2						
31. GOVT ARTS KOVIL	M 10		M 25				
32. TIRUVALLUVAR							
33. ST.JOHN'S					M 41		
34. MSU PANAGUDI	M 7						
35. ST.JOHN'S AMM.			M 21				
36. KAMARAJ SURA	M 15			M 37			
37. RAJALAKSHMI							
38. MSU S.KOVIL			M 29				
39. PERARIGNAR							M 49
40. RUBAN			M 19				
41. AMBAI ARTS				M 35			
42. S.T HINDU	M 4						
43. NANJIL			M 27				
44. K.R	M 12						
45. SSDM					M 43		
46. GOVT ARTS NAGER	M 8						
47. JP ARTS			M 23				
48. TMN COLLEGE				M 39			
49. VTM			M 31				
50. VOC							
51. SCOTT (W)							

\*Reporting Time – Oct 11, 2017 at 7.00am

Organizing Secretary: **Dr. A. LAURENCE SELVARAJ, DPE (9443080418)**

## HOCKEY (MEN)

**Venue:** K.R College of Arts 7 Science, Kovilpatti **Date:** Oct 20-21, 2017

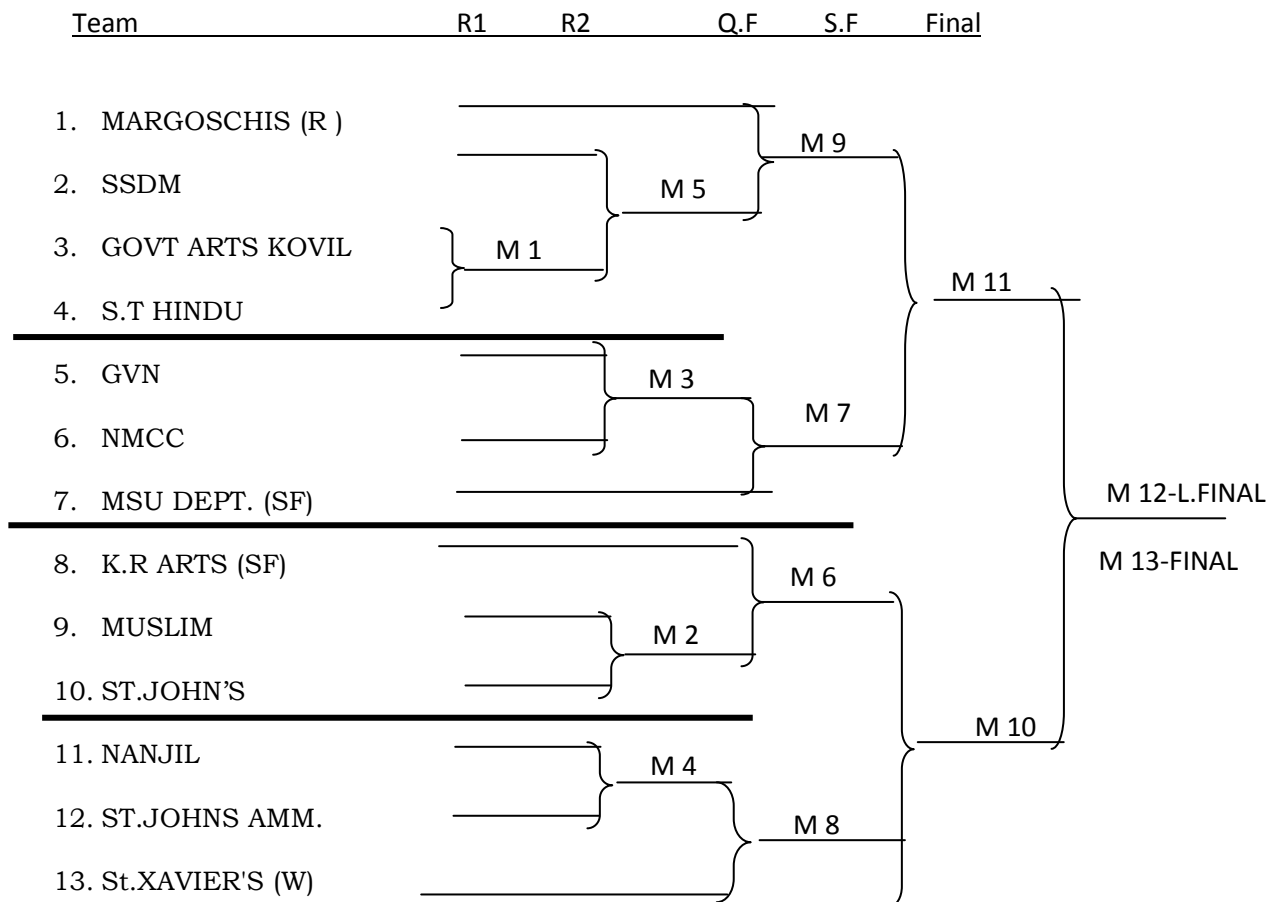

\*Reporting Time – Oct 20, 2017 at 7.00 am.

Organizing Secretary: **Dr. R.RAMKUMAR, DPE (9486454040)**

## KHO-KHO (MEN)

**Venue:** Nanjil Catholic College, Kaliyakkavilai

**Date:** Oct, 23-24, 2017

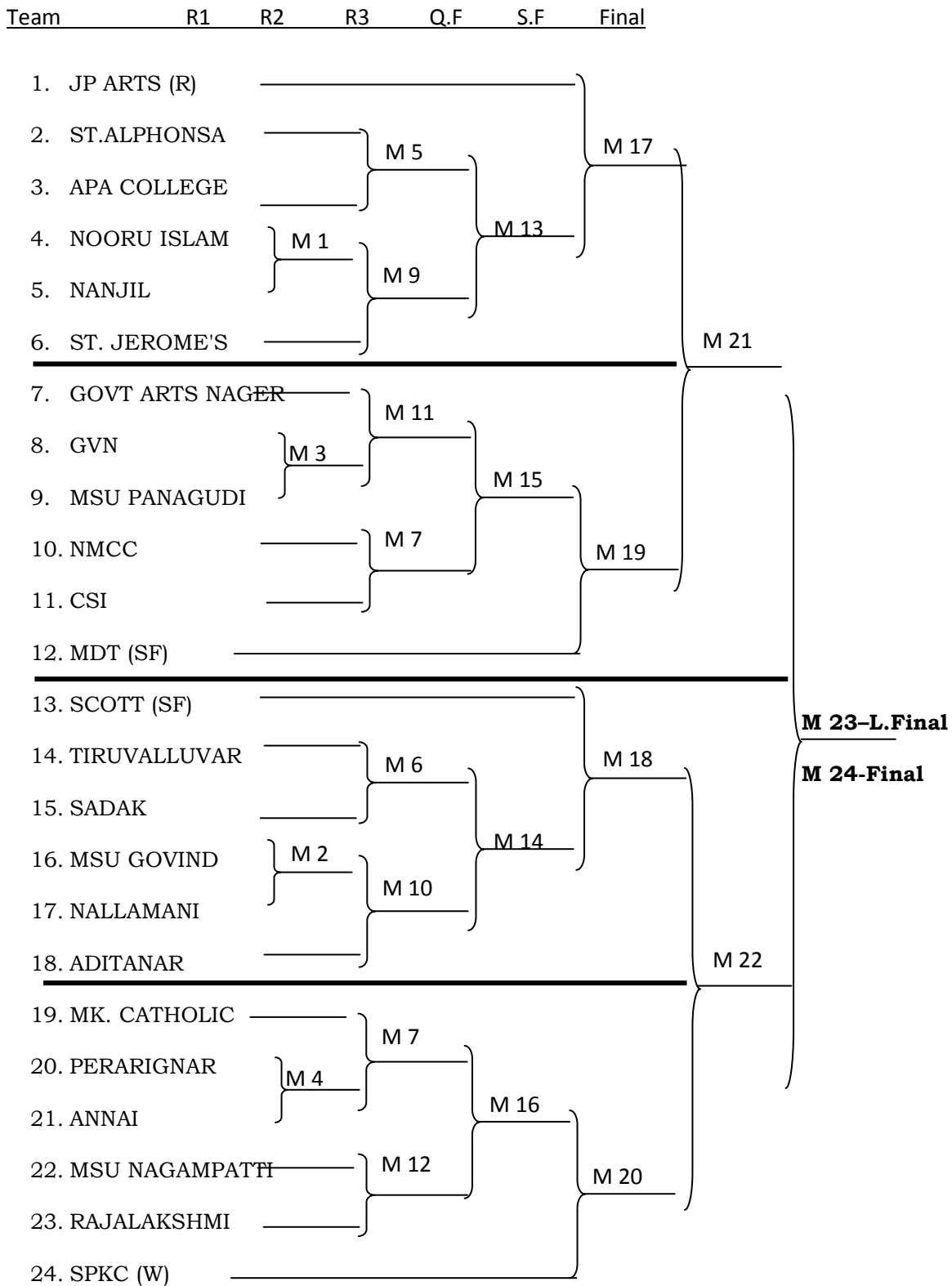

\*Reporting Time – Oct 23, 2017 at 7.00 am. Organizing Secretary : **Mr. JOY JOSE, DPE, (9942211907)**



## KABADDI (MEN)

**Venue:** M.S University, Tirunelveli

**Date:** Dec13-15, 2017

Team	R1	R2	R3	Q.F	S.F	Final
1. St.JEROME'S (R)						M 48
2. VTM		M 20				
3. MARGOSCHIS			M 36			
4. NALLAMANI	M 1					
5. K.R		M 24				
6. SRI KGS	M 5					
7. ST.ALPHONSA					M 44	
8. MSU K.NALLUR	M 5					
9. JP ARTS		M 28				
10. MSU S.KOVIL	M 13					
11. ENISTEIN			M 40			
12. MSU NAGALA	M 17					
13. NOORU ISLAM		M 29				
14. POPE'S						
15. GOVT ARTS NAGER		M 21				M 52
16. MSU PANAGUDI	M 3					
17. DON BOSCO			M 37			
18. RAJALAKSHMI	M 6					
19. AMBAI ARTS		M 25				
20. MSU GOVIND	M 10					
21. ANNAI					M 45	
22. NMCC	M 14					
23. ADITANAR		M 30				
24. KAMARAJ SURAN.	M 18		M 41			
25. MUSLIM					M 49	
26. KAMARAJ TUTI		M 33				
27. PERARIGNAR						
28. LEKSHMIPURAM(SF)						
29. SCOTT (SF)						M 53
30. MSU KANYA		M 22				
31. SADAK			M 39			
32. SARDAR RAJA	M 2					
33. RUBAN		M 27				
34. MSU DEPT.	M 7					
35. NANJIL					M 46	
36. MK. CATHOLIC	M 6					
37. PMT		M 32				
38. ST.JOHNS AMM.	M 15					
39. ST.XAVIERS			M 42			
40. VIVEKANANDA	M 19					
41. TIRUVALLUVAR		M 49				
42. SSDM						
43. MDT						M 51
44. MSU PULIYA						
45. APA COLLEGE	M 4		M 39			
46. GOVT ARTS KOVIL		M 27				
47. SPKC	M 8					
48. ST.JUDES					M 47	
49. MSU NAGAMPATTI	M 12					
50. GVN		M 32				
51. TDMNS	M 16		M 43			
52. CSI					M 51	
53. TMN COLLEGE		M 35				
54. VOC						
55. ST HINDU (W)						

\*Reporting Time – Dec 13, 2017 at 7.00 am.

Organizing Secretary: **Dr.C.DURAI, AP, (9865429632)**

## TABLE TENNIS (WOMEN)

**Venue:** Sri Parasakthi College for Women, Coutrallam

**Date:** Aug 24, 2017

Team	R1	Q.F	S.F	Final
1. SCOTT		_____		
2. SADAK		} M 1	} M 3	
3. GOVINDAMMAL		} M 1	} M 3	<b>M 5-L.Final</b>
4. PARASAKTHI		} M 2		<b>M 6-Final</b>
5. PUNITHA OHM		} M 2	} M 4	
6. St. MARY'S		_____		

\*Reporting Time – Aug 24, 2017 at 2.00 pm.

Organizing Secretary: **Dr.D.SAVITHIRI, DPE, (9486041168)**

## BALL BADMINTON(WOMEN)

**Venue:** St. Mary's College, Thoothukudi.

**Date:** Sep 11-12, 2017

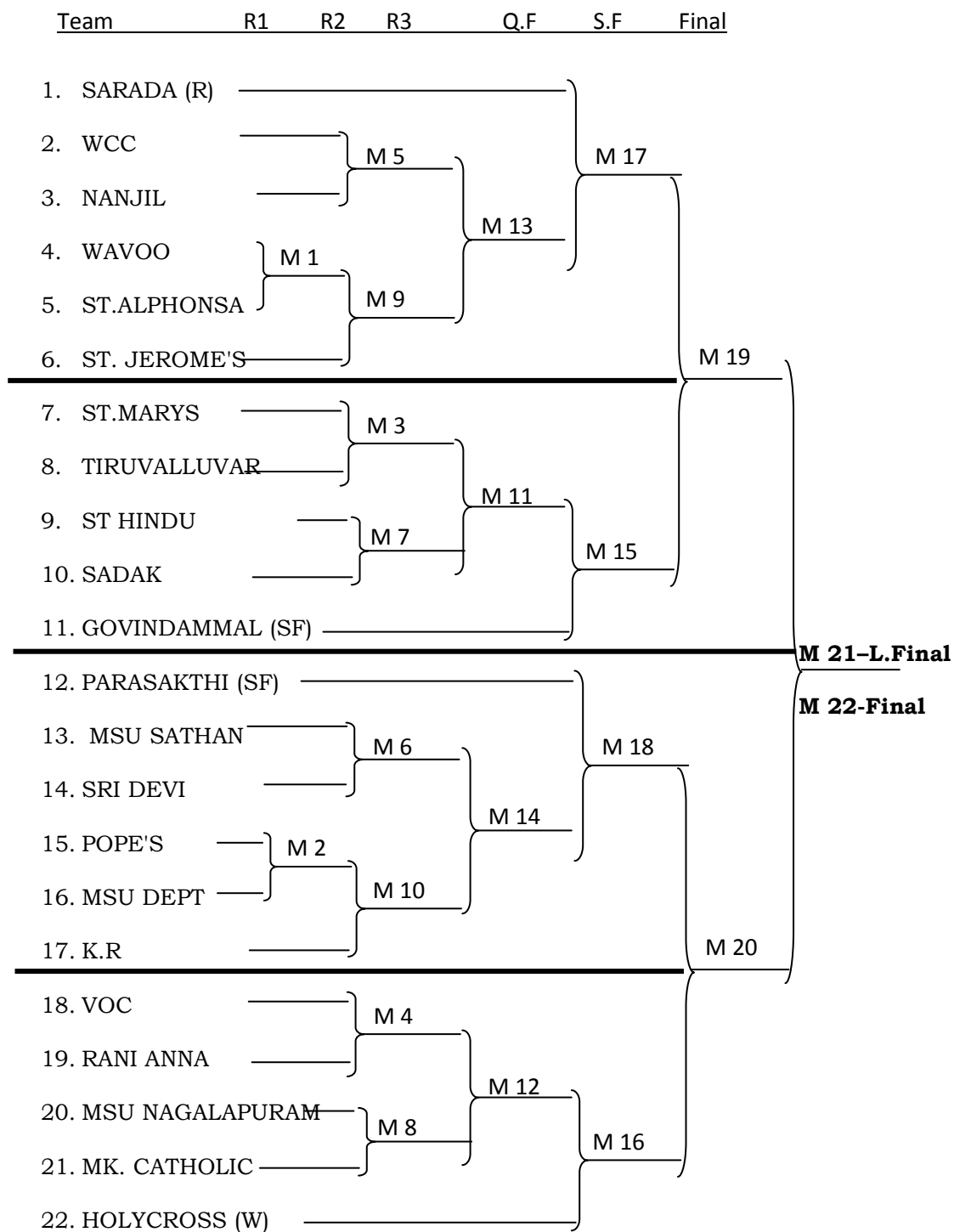

\*Reporting Time – Sep 11, 2017 at 2.00 pm.

Organizing Secretary: **Mrs. A.CHRISTY, DPE (7708071391)**

## KHO-KHO (WOMEN)

**Venue:** St. Mary's College, Thoothukudi.

**Date:** Sep 11-13, 2017

Team	R1	R2	R3	R4	Q.F	S.F	Final
1. GVOVINDAMMAL (R)							
2. GOVT ARTS NAGER					M 10		
3. MSU NAGALAPURAM						M 26	
4. SPKC					M 14		
5. SARDAR			M 1				
6. ST. JEROME'S							
7. SADAK			M 5				
8. ST.MARYS					M 18		
9. NOORU ISLAM					M 9		
10. GVN							
11. TIRUVALLUVAR					M 22		
12. POPE'S							M 42
<hr/>							
13. WCC					M 11		
14. MSU NAGAMPATTI						M 27	
15. PERARIGNAR ANNA					M 2		
16. KAMARAJ TUTI					M 15		
17. MK. CATHOLIC							
18. SCOTT					M 6		
19. VYASA ARTS							
20. CSI					M 19		
21. ST.JUDES							
22. PUNITHA OHM					M 23		
23. PARASAKTHI							M 44-L.Final
<hr/>							
24. JP ARTS							
25. NMCC					M 12		
26. MSU GOVINDAPERI						M 28	
27. RANI ANNA					M 16		
28. SRI KGS			M 3				
29. MSU SATHANKULAM							
30. ANNAI							
31. DON BOSCO					M 7		
32. VTM							
33. RUBAN					M 20		
34. MSU KANYA							M 43
<hr/>							
35. MSU PANAGUDI					M 13		
36. ST.ALPHONSA						M 29	
37. NANJIL					M 4		
38. WAVOO WAJEEHA					M 17		
39. MSU PULIYANKUDI							
40. HOLLY CROSS					M 8		
41. APC							
42. RAJALAKSHMI					M 21		
43. SRI DEVI							
44. MSU S.KOVIL					M 25		
45. SARADA (W)							M 41

\*Reporting Time – Sep 11, 2017 at 7 am

Organizing Secretary: **Mrs. A.CHRISTY, DPE (7708071391)**

## BADMINTON (WOMEN)

**Venue:** Lekshmipuram College, Neyyor, K.K.Dist

**Date:** Sep19-20, 2017

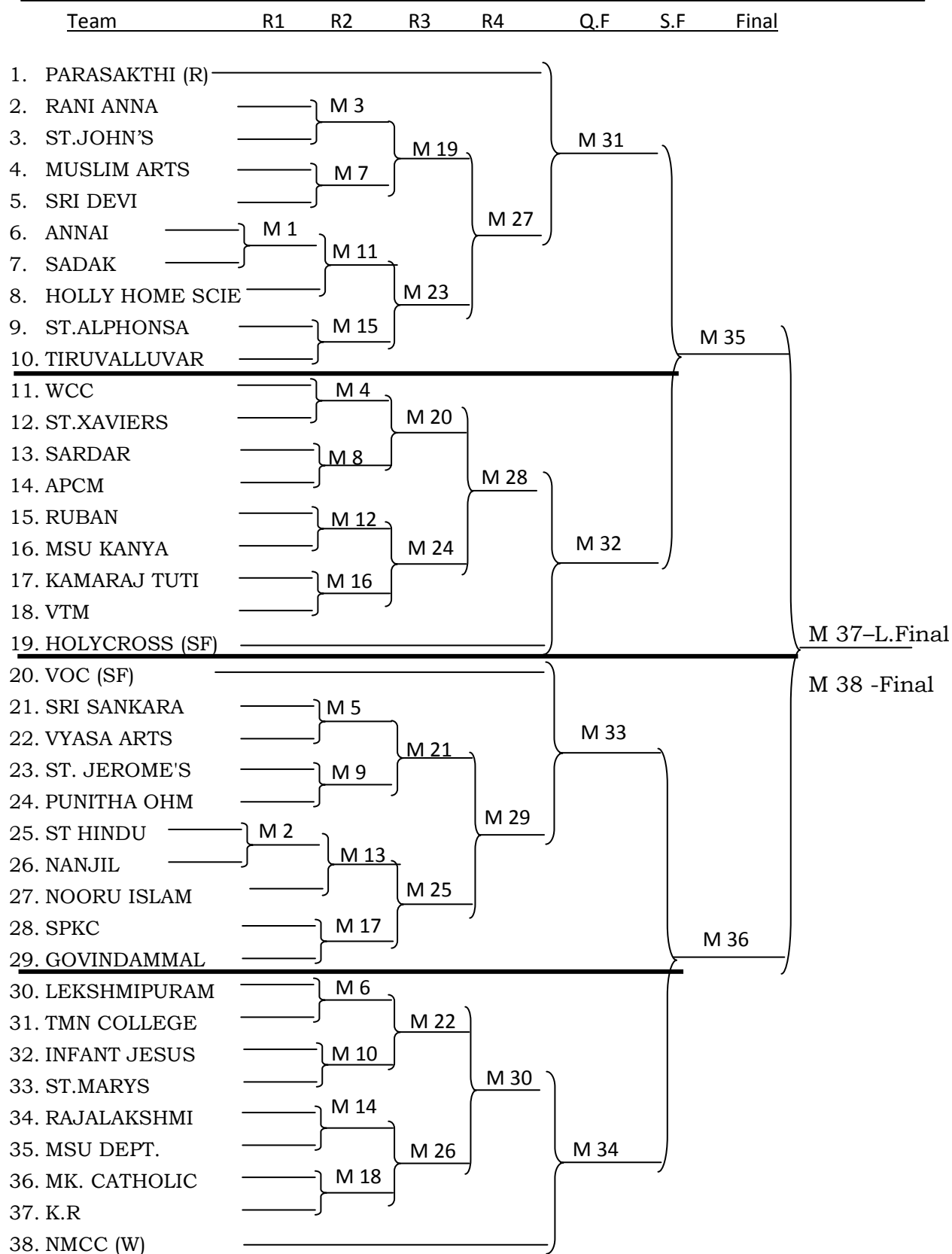

\*Reporting Time – Sep19, 2017 at 7.00 am. Organizing Secretary: **Mr. A. JERIN JOSE, DPE, (9443450789)**

## FOOTBALL(WOMEN)

**Venue:** MSU College, Puliyangudi

**Date:** Sep 25-27, 2017

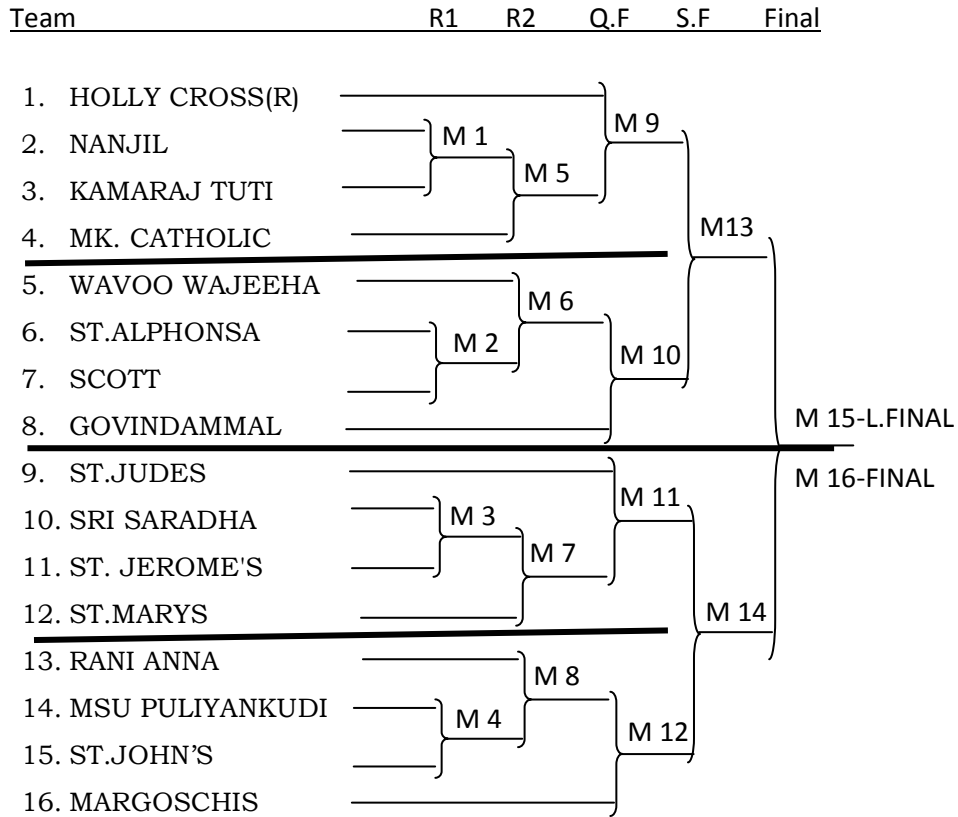

\*Reporting Time – Sep 25, 2017 at 7.00am

Organizing Secretary: **Mr. A.KUMARESA SRINIVASAN, DPE (7598728242)**

## KABADDI (WOMEN)

**Venue:** MSU College, Puliyangudi

**Date:** Sep 26-28, 2017

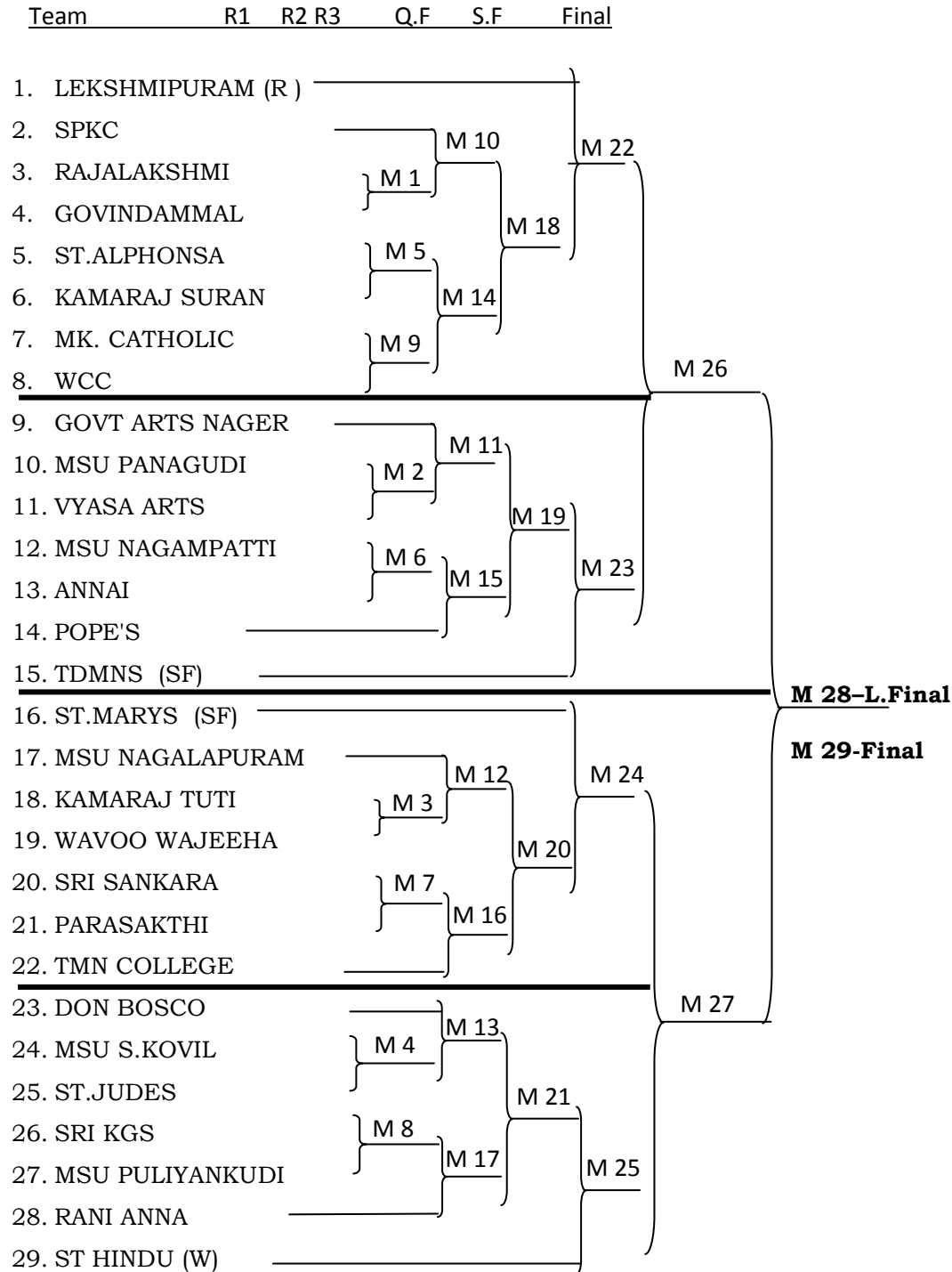

\*Reporting Time – Sep 26, 2017 at 7.00 am.

Organizing Secretary: **Mr. A.KUMARESA SRINIVASAN, DPE (7598728242)**

## VOLLEYBALL(WOMEN)

**Venue:** WCC College, Nagercoil

**Date:** Oct 9-11, 2017

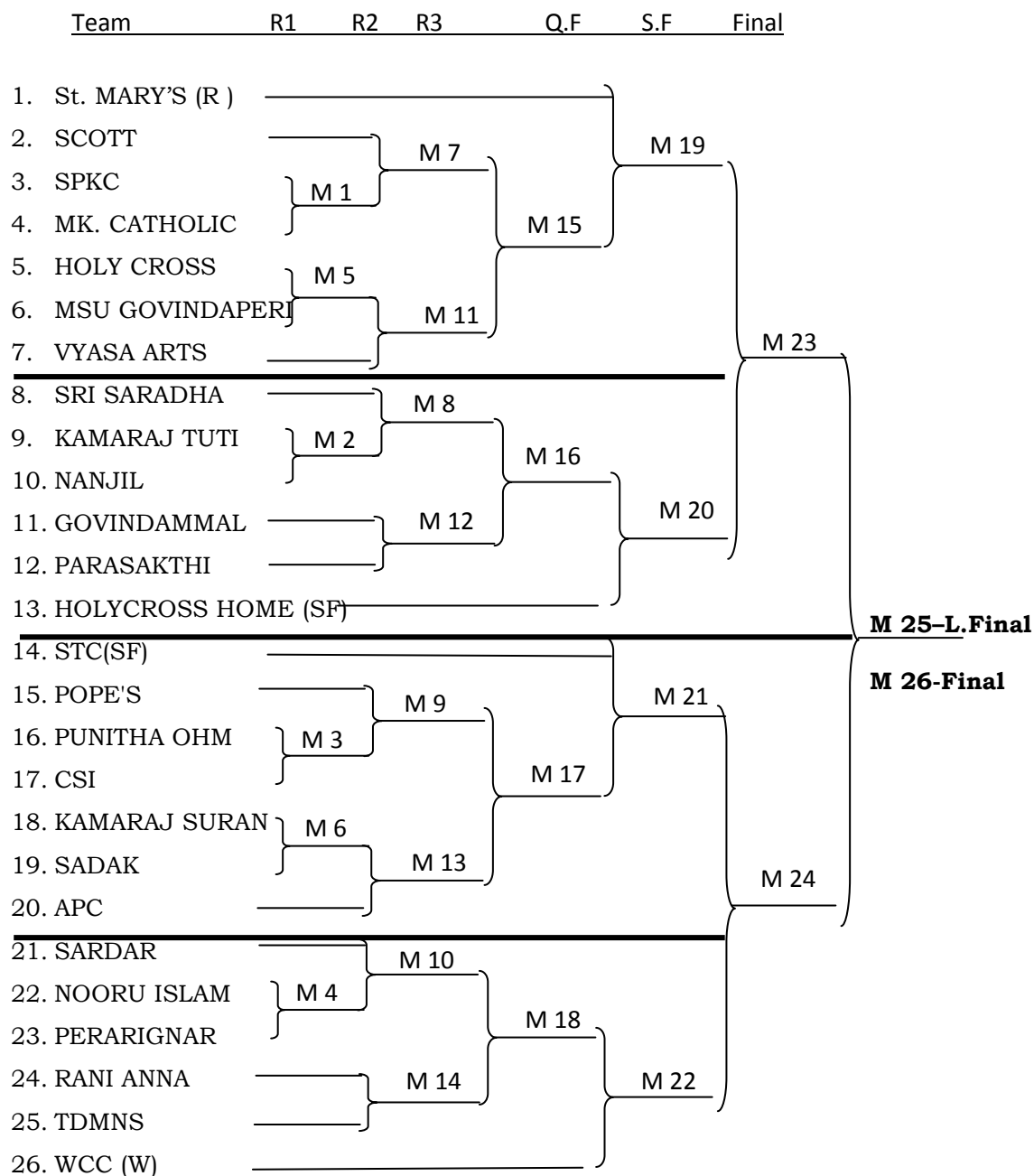

\*Reporting Time – Oct 9, 2017 at 7.00 am.

Organizing Secretary: **Dr. M.HEPSIBA JENI, DPE (9486110528)**



## HOCKEY (WOMEN)

**Venue:** MSU. KADAYANALLUR

**Date:** Oct25-27, 2017

<u>Team</u>	<u>Q.F</u>	<u>S.F</u>	<u>Final</u>
1. STC (R)	M 4	M 6	M 7 -L.Final
2. MSU KADAYANALLUR			
3. St. JOHN'S AMM	M 2		
4. S.T HINDU (SF)			
<hr/>			
5. PARASAKTHI (SF)	M 1	M 5	M 8 -Final
6. St. MARY'S			
7. SREE DEVI	M 3		
8. RANI ANNA (W)			

\*Reporting Time – Oct 25, 2017 at 7.00 am.

Organizing Secretary: **Dr.C.GURU CHIDRA SHANMUGA BHARATHI, DPE (9443190781)**



## HANDBALL (WOMEN)

**Venue:** MS University, Tirunelveli

**Date:** January 29-31, 2018

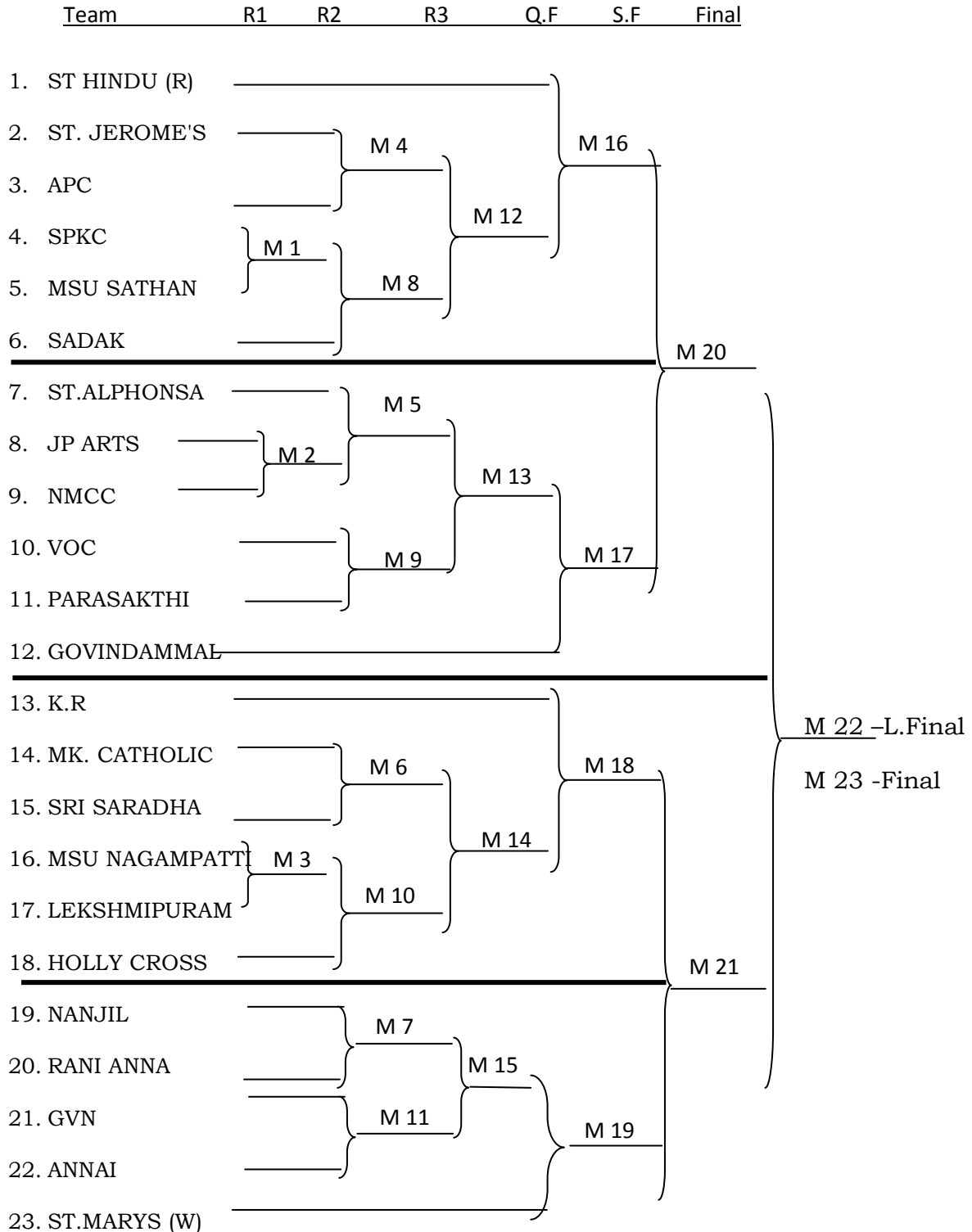

Organizing Secretary: **Dr. S. ARUMUGAM, AP, (9489233679)**